

3.75" 4 Вороток Набор патронов для токарных станков по дереву

1inch 8TPI

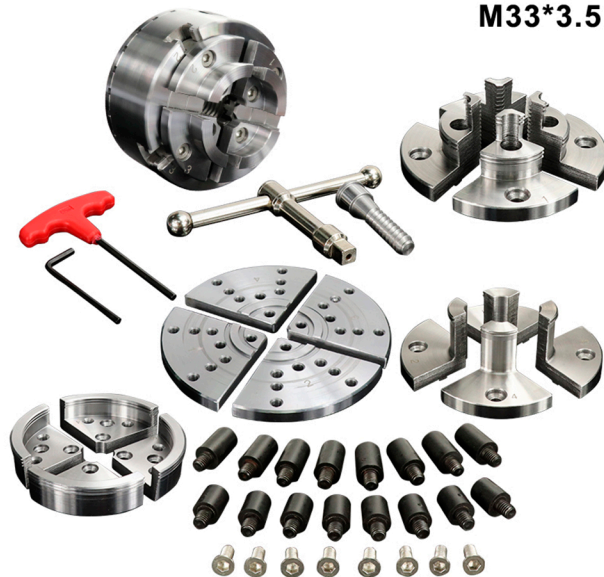

M33*3.5



SKU

375CLLH1INCH8TPI

375CLLHM3335

Specification

1inch 8TPI

M33x3.5

1 дюйм 8ТPI/М33*3.5 Патрон для токарных станков по дереву

1inch8TPI



M33x3.5



SKU

4100PJ1INCH8TPI

4100PJM3335

Specification

1inch 8TPI

M33*3.5

4 дюйма Патрон для токарных станков по дереву

1"8TPI



M33*3.5



SKU

4DXKPPJ18TPI

4DXKPPJM3335

Specification

Type C 1inch 8TPI

Type C M33x3.5

Патрон для токарных станков по дереву

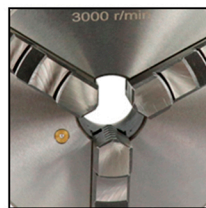

SKU

3ZKP125MM

Specification

125mm

4 Вороток Патрон для токарных станков по дереву

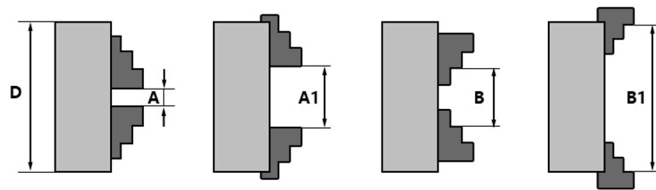

Clamping Range

Model	D Size	Internal jaws damping range	External jaws damping range
		A-A1	B-B1
105240	80	5-35	35-80
105241	100	6-45	40-100
105242	125	7-57	48-125

SKU

4ZKPK72100

4ZKPK72125

4ZKPK7280

Specification

K72-100

K72-125

K72-80

Шпиндельный адаптер Переходник (адаптер) для патронов для токарных станков по дереву



femal thread M18 * 2.5mm

male thread M33 * 35mm



femal thread 1-8TPI

male thread M33 * 35mm

SKU

BJT001

BJT002

Specification

M33x3.5 to M18x2.5

M33x3.5 to 1-8TPI

Шпиндельный адаптер Переходник (адаптер) для патронов для токарных станков по дереву

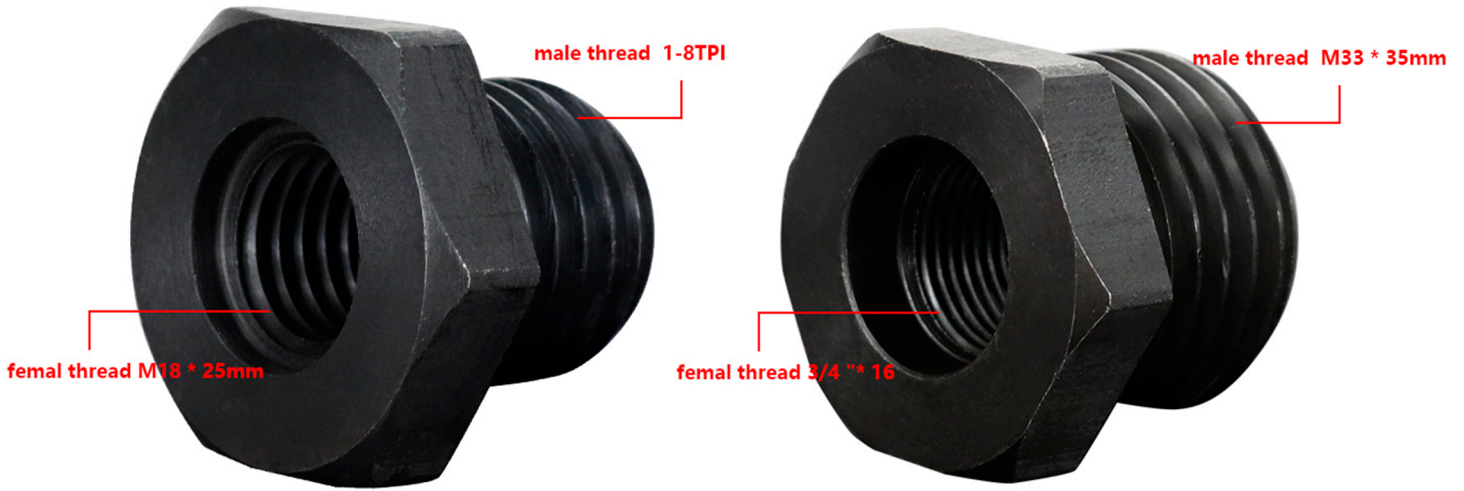

SKU

BJT005

BJT008

Specification

1-8TPI to M18x2.5

M33x3.5 to 3/4x16

6 колес

Токарные инструменты для накатки

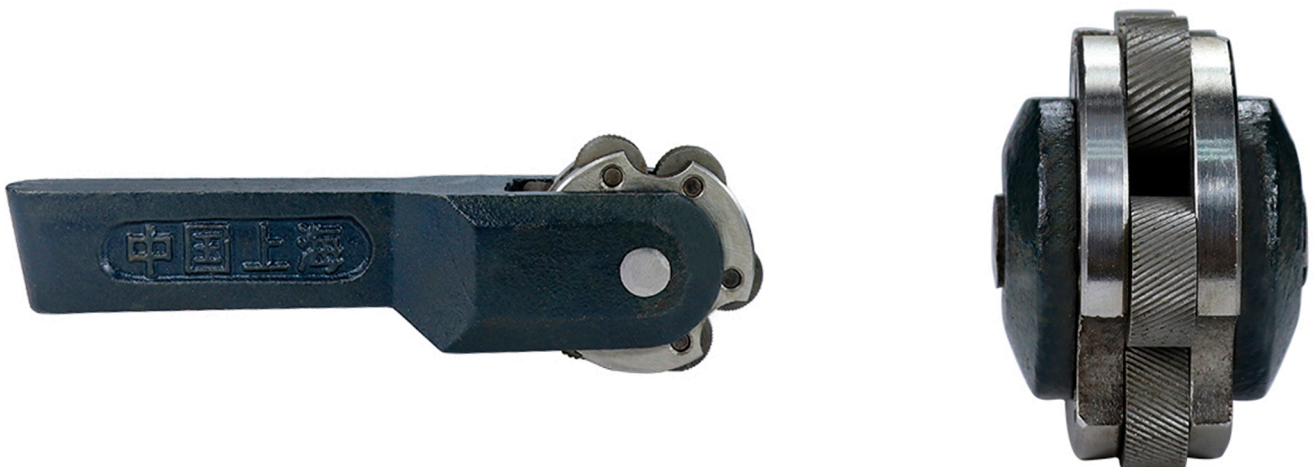

SKU

CCYHLLGHD

Specification

6 Wheel

ержавка для накатки с роликами



SKU

WDJBHLZ

Specification

Holder

7PCS Токарные державки для накатки



Diagonal Knurling Wheel

Knurling pitch: 0.5/0.8/1.0/1.2/1.5/1.6/1.8/2.0mm
Hanawa outer diameter: 26mm(1.02 inch)
Hanawa inner diameter: 8mm(0.3 inch)
Hanawa Thickness: 8mm/0.31 inch

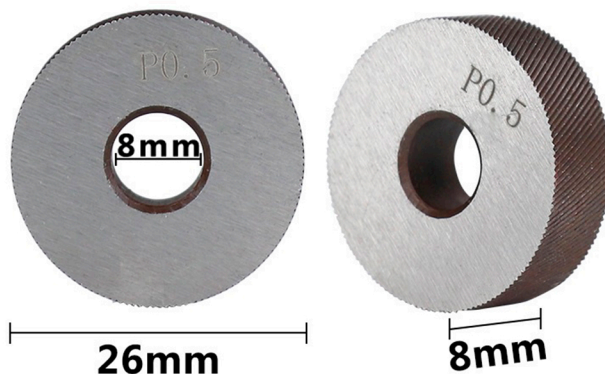

SKU

WWGH7PC

Specification

Holder+2PCS(0.5 1.0 2.0)

0.5-2.0mm Набор токарных инструментов для накатки

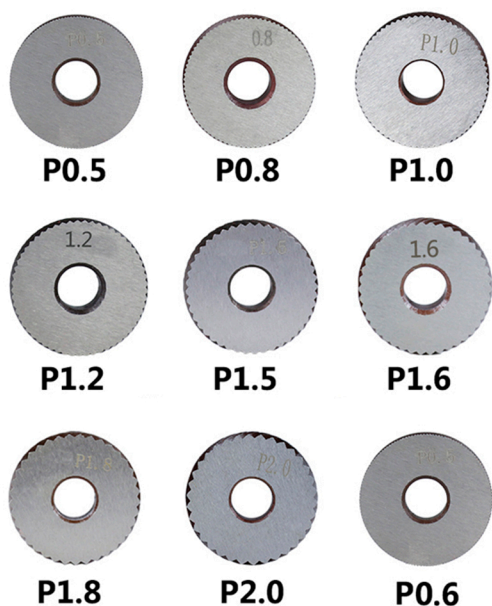

SKU

Specification

WDJBHLZ05	Holder+(0.5 2 stuks)
WDJBHLZ06	Holder+(0.6 2 stuks)
WDJBHLZ08	Holder+(0.8 2 stuks)
WDJBHLZ10	Holder+(1.0 2 stuks)
WDJBHLZ12	Holder+(1.2 2 stuks)
WDJBHLZ15	Holder+(1.5 2 stuks)
WDJBHLZ16	Holder+(1.6 2 stuks)
WDJBHLZ18	Holder+(1.8 2 stuks)
WDJBHLZ20	Holder+(2.0 2 stuks)

0.5-2.0mm Резак для накатки

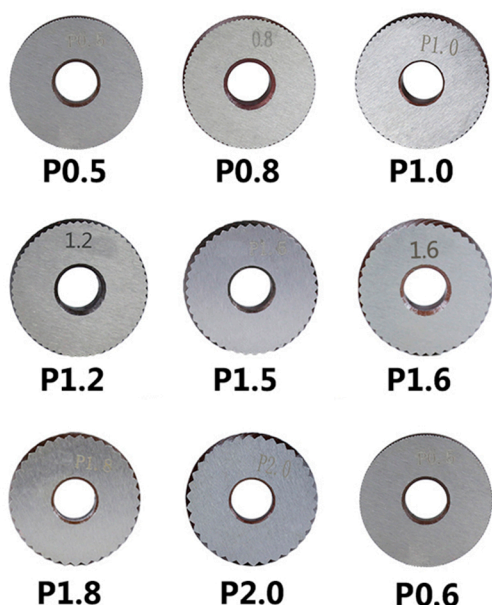

SKU

Specification

WWGHL05	0.5 2 stuks
WWGHL06	0.6 2 stuks
WWGHL08	0.8 2 stuks
WWGHL10	1.0 2 stuks
WWGHL12	1.2 2 stuks
WWGHL15	1.5 2 stuks
WWGHL16	1.6 2 stuks
WWGHL18	1.8 2 stuks
WWGHL20	2.0 2 stuks

0.5-2.0mm

Линейный накатной инструмент

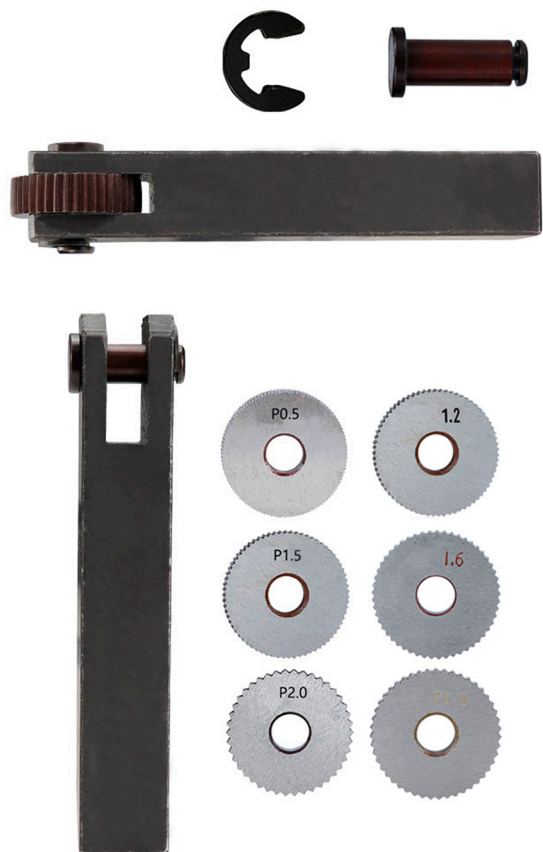

SKU

Specification

ZWGHDDJBHLZ	Holder
ZWGHDDJBHLZ05	Holder+0.5
ZWGHDDJBHLZ06	Holder+0.6
ZWGHDDJBHLZ08	Holder+0.8
ZWGHDDJBHLZ10	Holder+1.0
ZWGHDDJBHLZ12	Holder+1.2
ZWGHDDJBHLZ15	Holder+1.5
ZWGHDDJBHLZ16	Holder+1.6
ZWGHDDJBHLZ18	Holder+1.8
ZWGHDDJBHLZ20	Holder+2.0
ZWGH7PC	Holder+2PCS(0.5mm 1.5mm 2.0mm)

0.5-2.0mm

Прямой накатной резак

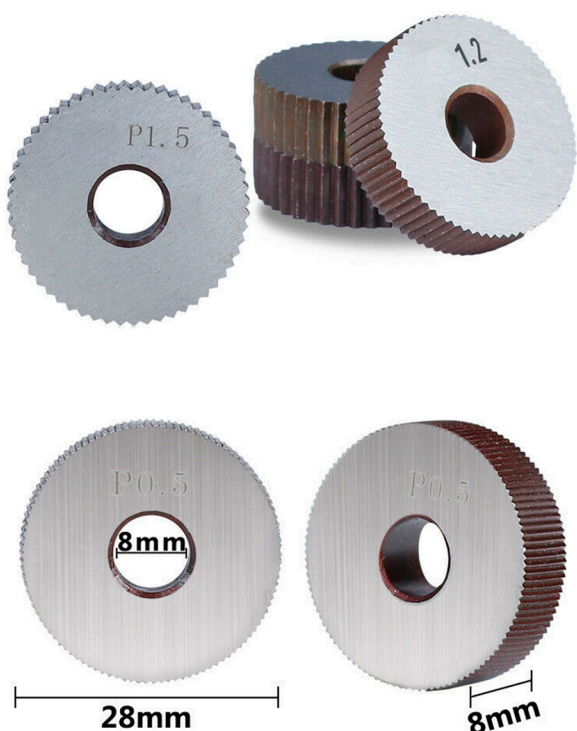

SKU

Specification

ZWGHL05	0.5
ZWGHL06	0.6
ZWGHL08	0.8
ZWGHL10	1.0
ZWGHL12	1.2
ZWGHL15	1.5
ZWGHL16	1.6
ZWGHL18	1.8
ZWGHL20	2.0

MT1-MT4 Инструмент для токарного станка Live Center Taper Tool

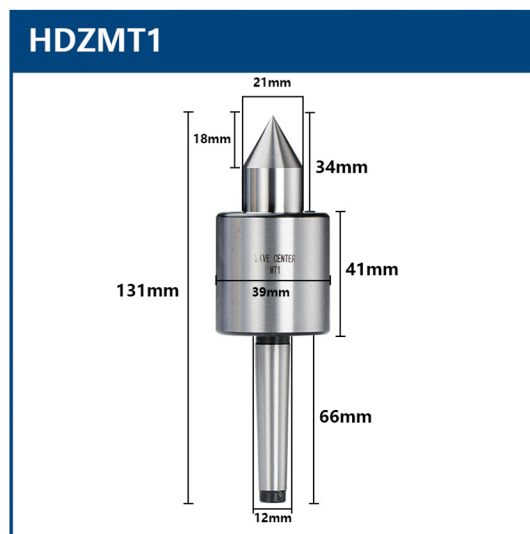

SKU

HDZMT1

HDZMT2

HDZMT3

HDZMT4

Specification

MT1

MT2

MT3

MT4

MT1-MT3 Конусный инструмент с вращающимся наконечником

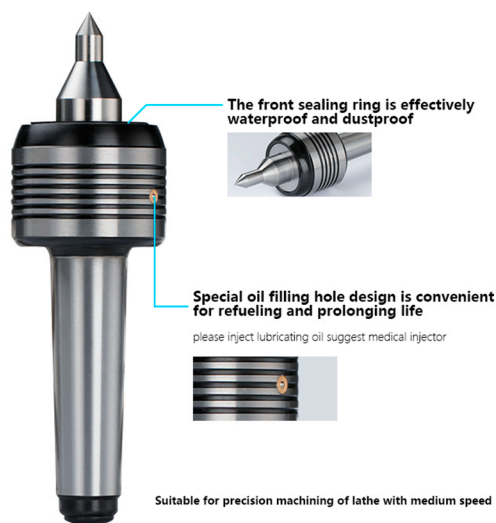

SKU

HZDZMT1

HZDZMT2

HZDZMT3

Specification

MT1

MT2

MT3

MTB2-MTA4 ER25 Переходная втулка с затягивающим винтом



SKU

Specification

LJGMTA2ER25

MTA2 ER25

LJGMTA3ER25

MTA3 ER25

LJGMTA4ER25

MTA4 ER25

LJGMTB2ER25

MTB2 ER25

LJGMTB3ER25

MTB3 ER25

LJGMTB4ER25

MTB4 ER25

ER25 Набор цанговых патронов



SKU

Specification

LJGMTA2ER25A

MTA2 ER25+ER25 (3 4 5 6
8 10 12 14 16) +ER25UM

LJGMTA3ER25A

MTA3 ER25+ER25 (3 4 5 6
8 10 12 14 16) +ER25UM

LJGMTA4ER25A

MTA4 ER25+ER25 (3 4 5 6
8 10 12 14 16) +ER25UM

LJGMTB2ER25A

MTB2 ER25+ER25 (3 4 5 6
8 10 12 14 16) +ER25UM

LJGMTB3ER25A

MTB3 ER25+ER25 (3 4 5 6
8 10 12 14 16) +ER25UM

LJGMTB4ER25A

MTB4 ER25+ER25 (3 4 5 6
8 10 12 14 16) +ER25UM